

KANSAS

THEN & NOW



Hello friends!

Kansas: Then & Now was created by our office to provide fun activities while also learning more about our great state. Kansas is a historically rich state with breathtaking scenery and friendly, hardworking, down to earth people. Our hope is this book helps you know more about how Kansas became a state, the different branches of government, our state economy and the diverse geography of Kansas.

Growing up in Great Bend and attending college at Fort Hays State University helped me fall in love with Kansas. From hunting in shelter belts, to eating mulberries by the Dry Walnut Creek and visiting the State Fair or watching a shoot-out in Dodge City, Kansas has something to offer everyone. As a father, there is no other place that I would rather raise my family than Kansas.

Kansas is a special place I love to brag about it when I travel or visit with my fellow Secretaries of State. I hope this booklet inspires you to explore our state and tell others why you love Kansas. Trust me, you don't want to miss a single corner. So ask yourself, "where in Kansas can we go today?"

With gratitude,



Scott Schwab
Kansas Secretary of State



KANSAS HISTORY

Between 1541 and 1739, the first European explorers from Spain and France arrived in modern day Kansas looking for gold, trade and knowledge. The land was included as part of the Louisiana Purchase in 1803. After 51 years, Kansas became an official territory on May 30, 1854, because of the Kansas-Nebraska Act.

Four different constitutions were proposed when Kansas became a territory: the Topeka constitution (1855), the Lecompton constitution (1857), the Leavenworth constitution (1858) and the Wyandotte constitution (1859). The Topeka, Lecompton and Leavenworth constitutions all supported "Big Kansas" which included the Rocky Mountains, the eastern half of modern-day Colorado and southern Nebraska as part of the Kansas territory. Some settlers were worried the territory proposed under "Big Kansas" was too big so they proposed "Little Kansas" which removed

the Colorado and Nebraska sections from the territory. When Kansas became a state in 1861 the Wyandotte constitution was adopted along with the boundaries of "Little Kansas," making Kansas the size it is today.

Kansas has long been a moral testing ground in America. In the mid-1850s, conflict over whether Kansas would be a "slave state" led to many bloody battles between freestaters and proslavery forces. The battles were so fierce Kansas earned the nickname "Bleeding Kansas." Kansas joined the Union as a free state in 1861 and Topeka was named the state capital.

When the Civil War began a few months later in April 1861, two-thirds of all men in Kansas were enlisted in the Union Army. Kansas had the most casualties, per capita, then any other state in the Union. Over 8,000 men were killed or wounded.



SKI KANSAS?

When the Kansas Territory was formed in 1854 it stretched all the way to the Rocky Mountains in present day Colorado. Can you imagine being able to go skiing, mountain climbing or seeing a bear in Kansas?

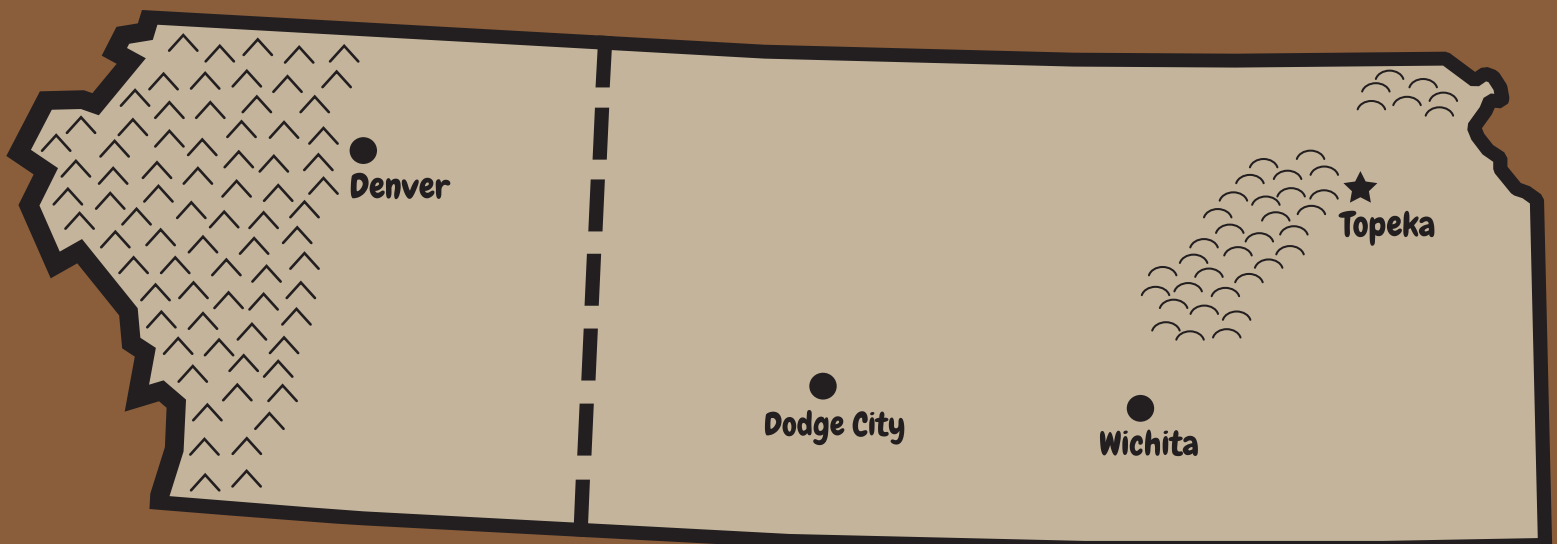

KANSAS HISTORY

After the Civil War, settlers moved west to start a new life in states like Kansas. Native Americans didn't like the new settlers entering their territory. Neither side trusted the other, so to keep the two sides from fighting, military posts were built throughout Kansas. Small towns with schools, churches and businesses were built near the posts which helped grow the population of Kansas.

By 1872, the Kansas Pacific Railroad (now Union Pacific) and Santa Fe Railway had been built in

Kansas. Railroads brought cattle drives to towns like Dodge City, Abilene, Newton and Wichita making them important shipping centers for railroads. A few years later, in 1874, Russian Mennonites planted Turkey Red Wheat because the weather was perfect for growing it. Thanks to the new wheat, Kansas quickly became the leading wheat producer in the United States of America. Railroads, cattle and wheat allowed Kansas to grow. The three still play an important role in the economy of Kansas.



Native Americans in Kansas

Native American culture and language have had an enormous impact on the history of our state. Seven different Native American tribes originally lived on the plains of present-day Kansas. Additional tribes of emigrant Native Americans were forced to relocate to Kansas as part of the Indian Removal Act of 1803.

ARAPAHO INDIANS lived in northwest Kansas. They were considered “peaceful people” because they did not fight the invading settlers. Instead they made treaties with settlers which resulted in their later expulsion from Kansas.

PAWNEE INDIANS are from north central Kansas. Their warriors had shaved heads except for a small patch of hair called a “scalp-lock.” The scalp-lock was similar to a mohawk but cut short and stiffened with buffalo fat. The name Pawnee comes from the word pa-rik-i, meaning a horn.

KANSA INDIANS resided in northeast Kansas and lived in round lodges made of wood and packed earth. Kansas was named after the Kansa, or Kaw tribe, and means “south wind people.”

OTO-MISSOURI INDIANS are from the far northeast corner of Kansas. Early on the tribe had over 1,000 people residing

along the Platte River. Much of the tribe was killed in a smallpox outbreak and the survivors joined a related tribe, the Missouris.

COMANCHE INDIANS arrived in southwest Kansas after being driven from their homeland in Wyoming by their enemies, the Sioux. They roamed as far as Chihuahua, Mexico. They got along with most Americans, but fought with Mexican Spaniards for over 200 years.

KIOWA INDIANS lived in central and southern Kansas. People thought this tribe was the fiercest of all tribes. Kiowa warriors wore long red sashes and pinned them to the ground with an arrow to show they would fight to the death.

OSAGE INDIANS resided in southeast Kansas. The name Osage is the French distortion of the tribe’s original name – the Wazhazhe.

EMIGRANT TRIBES who came to Kansas after the Indian Removal Act of 1803 were the Cherokee, Chippewa, Delaware, Illini, Iowa, Kickapoo, Potawatomi, Sac and Fox, Seneca, Shawnee and Wyandotte.

IMPORTANT DATES IN KANSAS HISTORY

1541

Spanish explorer Francisco Vasquez de Coronado becomes the first white man to enter modern day Kansas.



1803

The United States purchases Kansas as part of the Louisiana Purchase with France.

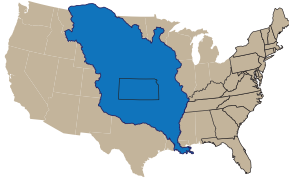

1854

Kansas organizes as a territory. The territory includes all of Kansas and half of present-day Colorado.



1855 to 1861

Fierce battles erupt between those who want Kansas to enter the Union as a free state and those who want Kansas to be a slave state. This period earns Kansas the nickname "Bleeding Kansas."

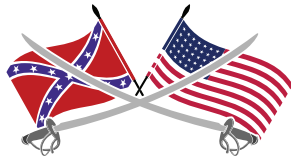

1861

Kansas is admitted as the 34th state in the Union. Topeka is named the Capital City.



1874

Turkey Red Wheat is introduced in Kansas propelling the state as a national leader in agricultural production.



1903

After 37 years, construction on the Kansas Statehouse is complete. The cost - \$3.2 million.



1930 to 1939

A devastating drought causes most of Kansas to be caught in the "Dust Bowl."

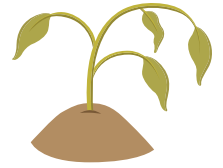

1952

Dwight D. Eisenhower is elected the 34th President of the United States.



1954

The U.S. Supreme Court declares segregation in schools as unconstitutional in its *Brown v. Topeka Board of Education* decision.



1978

Nancy Landon Kassebaum is elected as the state's first female U.S. senator.

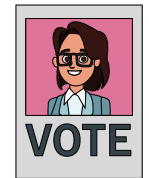

1991

Joan Finney is sworn in as the first female governor of Kansas.



1996

Kansas Senator Bob Dole is named the Republican Party nominee for President of the United States. He was defeated by incumbent President Bill Clinton.

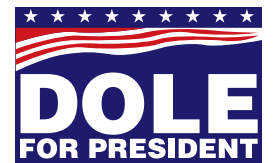

2009

Manhattan, Kansas is selected as the new location for the National Bio and Agro-Defense Facility.



2013

Sporting Kansas City wins the Major League Soccer Championship.



KANSAS SYMBOLS

State Flag

The Legislature approved the Kansas flag in 1927. It was flown for the first time over Fort Riley by Governor Ben Paulen to honor the troops and Kansas National Guard. The flag is a dark blue rectangle with the state seal in the middle. Above the seal is the state crest – a sunflower sitting on a twisted bar of blue and gold representing the Louisiana Purchase. “Kansas” in gold lettering was added in 1961. State law requires the flag to be used “on every and all occasions, when the state is officially and publicly represented.”



Great Seal

On May 25, 1861, the Great Seal of the State of Kansas was created to help describe the history of Kansas. In the seal, the east is represented by a rising sun. The river and steamboat signify industry. You can see the importance of agriculture to Kansas by the man plowing land next to the settler’s cabin. Look closely, can you see the wagon train? You can also see a herd of buffalo being hunted by Native Americans riding horses. At the top of the seal is the state motto and 34 stars to reflect Kansas was the 34th state to join the Union.

State Motto

“Ad Astra Per Aspera” is the state motto. It means “to the stars through difficulties.” The motto was used by John J. Ingalls. Mr. Ingalls believed Kansans could realize the impossible if they worked through their difficulties. To make it sound better he said it in Latin and people liked it. Today, there is a statue on the top of the Kansas Statehouse called Ad Astra. It was added in 2002 and shows a Kansa warrior aiming his bow and arrow toward the North Star.



ACTIVITY

Color in the state seal by matching the number in the seal with the color at the bottom of the page.

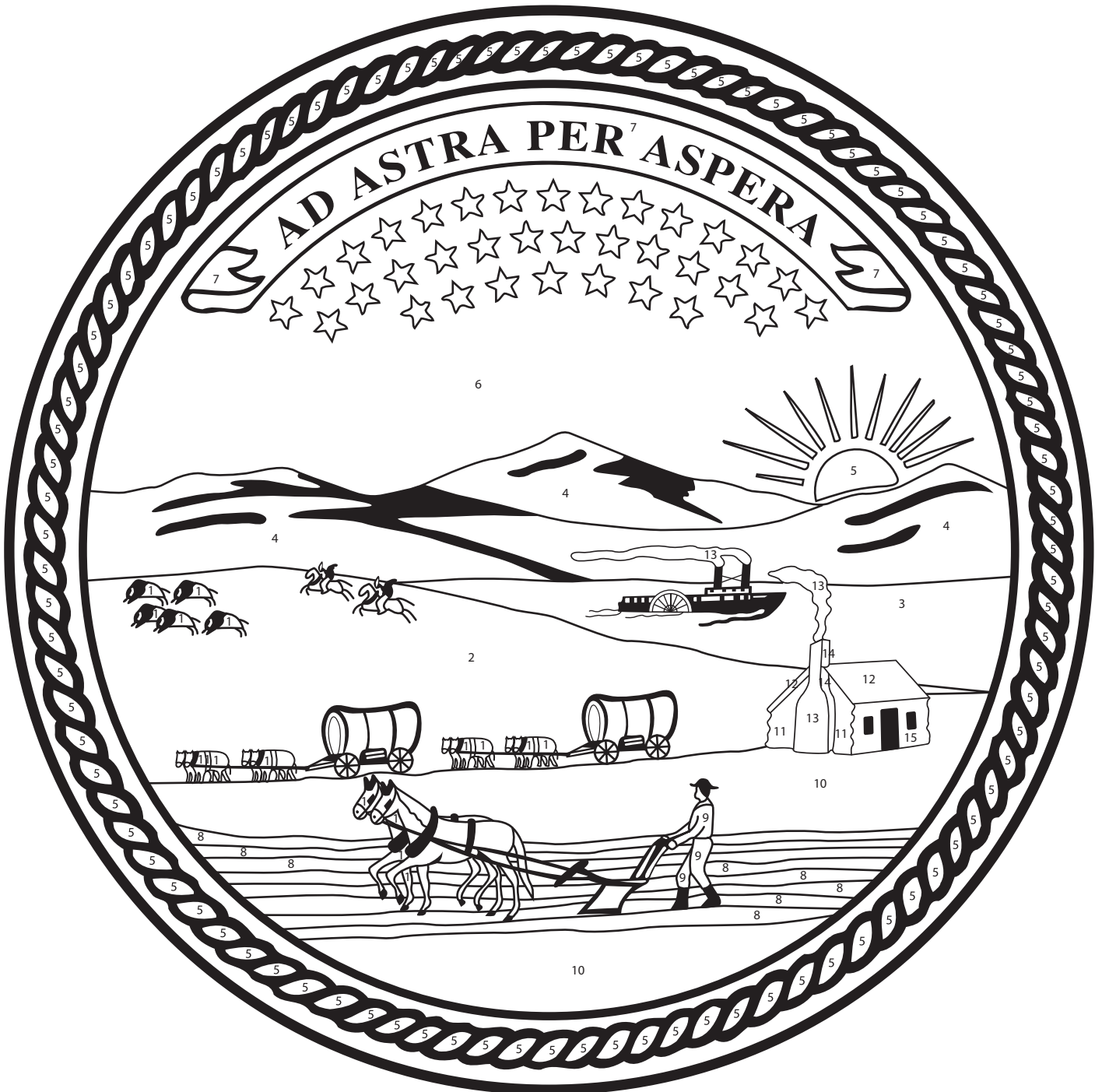

KANSAS CONSTITUTION

"We, the people of Kansas, grateful to Almighty God for our civil and religious privileges, in order to insure the full enjoyment of our rights as American citizens, do ordain and establish this constitution of the state of Kansas..."

— Preamble of the Kansas Constitution

The Kansas Constitution was originally known as the Wyandotte Constitution. In 1859, 52 people met for a constitutional convention in Wyandotte County. The average age of the delegates was 35. They were normal people with normal jobs – business owners, farmers, lawyers, doctors, mechanics and printers. Although young and inexperienced, they worked together to create the Kansas Constitution as a symbol of freedom during an ugly fight over slavery in the United States.

The constitutional convention included controversial issues for the time - slavery and voting rights. The approved constitution, called

the Wyandotte Constitution, prohibited slavery, but it did not give women, African Americans or Native Americans the right to vote. The Legislature adopted the Wyandotte Constitution on July 29, 1859, and it was approved by Kansas voters on October 4, 1859. However, it was not the official constitution of Kansas until it was approved by the U.S. House of Representatives and U.S. Senate and signed by the President. President James Buchanan signed the bill on January 29, 1861, making Kansas the 34th state to enter the Union. Kansans celebrate the birthday of Kansas, called Kansas Day, every year on January 29th.

KANSAS GOVERNMENT

The Kansas Constitution formed a government like the federal government. It has three branches of government - the executive branch, legislative branch and judicial branch. The biggest difference is with the executive branch. Typically, the executive branch is only the governor. Kansas has an executive department as its executive branch. The department includes the governor, lieutenant governor, secretary of state and attorney general. Two other statewide offices, the insurance commissioner and state treasurer, were created by state law, not the state constitution.

Like the U.S. Constitution, the Kansas Constitution outlines the responsibilities of each branch of government. The main job of each branch is to balance the others so one does not become too powerful. The executive branch oversees the daily duties of running the state, the legislative branch creates laws that govern the state and the judicial branch interprets and applies the laws.

Executive Branch

The executive branch enforces or carries out the laws created by the legislative branch. The governor is the highest elected official followed by the lieutenant governor, secretary of state and attorney general. The executive branch has many responsibilities including signing bills, creating the state budget, overseeing elections, representing the state in court, regulating insurance companies and banks and much more.

Legislative Branch

The legislative branch is responsible for making and maintaining laws for the State of Kansas. The Kansas Legislature has two bodies – the House of Representatives and the Senate. Members of the Kansas House and Senate are elected to represent a specific area called a district.

The Kansas Senate is the upper chamber of the legislature. They pass laws and have a special job of confirming or rejecting appointments from the governor. There are 40 senators in the Senate. Each member represents a district of approximately 72,000 people. Senators are elected to four-year terms. The Kansas House of Representatives is the lower chamber of the Legislature. It has 125 members who represent approximately 22,000 people per district. Representatives are elected every two years.

Judicial Branch

The Supreme Court is the highest court in Kansas. It has seven judges – a chief justice and six justices. Justices must be at least 30 years old and licensed to practice law in Kansas. The Supreme Court hears appeals from lower courts on cases where a law may be unconstitutional. The Supreme Court does not hold trials but makes their decision by interpreting the law, reviewing notes from the lower courts and reading arguments from attorneys. The Supreme Court oversees all other courts in Kansas and can discipline a judge, attorney or court employee.

The Kansas Court of Appeals is the second highest court in Kansas. It has a chief judge and 13 judges. The job of the Kansas Court of Appeals is to review cases that have already been tried in lower courts. Like the Supreme Court, there is no trial. Court of Appeals judges interpret the law. Although all 14 members may hear an appeal, they normally sit in panels of three in different locations throughout Kansas.

District courts are the trial courts of Kansas. There are 31 judicial districts in Kansas and each one has at least one district judge. Local jurisdictions, like cities and counties also have courts to oversee local matters.

KANSAS GEOGRAPHY

Kansas is the geographic center of the contiguous 48 states, earning us a nickname of the "nation's heartland." The average temperature in Kansas is 56 degrees with an average rainfall of 27 inches a year. Kansas is the 14th largest state in the United States measuring at 411 miles long and 208 miles wide. The lowest part of the state is in southeast Kansas (700 ft) while the highest is in western Kansas (4,000 ft). As a result of our diverse geography there is great variation in the climate, terrain, soil, plants and animals in Kansas.

Kansas has more than 10,000 miles of open streams and rivers. The Arkansas, Missouri and Kansas (or Kaw) Rivers are the largest rivers in Kansas. There are also 43 state fishing lakes, 230 community lakes, 24 large federal reservoirs, 26 state parks and 104 wildlife areas.

Monument Rocks, or Chalk Pyramids, are located in western Kansas. They were created over 80 million year ago by the erosion of the Western Interior Seaway which covered much of what is now North America. They are made of soft limestone and can be easily harmed.

Kansas Facts

Population

2.9 million



Capital

Topeka



Largest City

Wichita



Size

411 miles x 208 miles

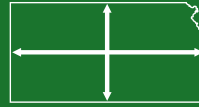

Counties

105

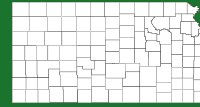

State Song

Home on the Range



State Animal

American Buffalo



State Insect

Honeybee



State Reptile

Ornate Box Turtle



State Flower

Sunflower



State Bird

Western Meadowlark



State Tree

Cottonwood



KANSAS GEOGRAPHY

Ogallala Aquifer

The Ogallala is one of the world's largest aquifers. You are probably wondering how do you say Ogallala and what is an aquifer? First, Ogallala is pronounced oh-guh-LAH-luh. An aquifer is an underground layer of rock with water in it. It sits under eight states and covers 174,000 miles. The aquifer is refilled by rain and melting snow.

The Ogallala Aquifer has provided water to Kansas farmers for a very long time. They use wells and irrigation systems to pump water from the aquifer to water crops, feed animals and provide for themselves. However, it has been used so much the water level is quickly declining and we do not get enough rain or melting snow to refill it. Farmers and scientists are working together to find ways to save water and help keep more water in the aquifer. Without the Ogallala Aquifer, thousands of acres of farmland could be destroyed.

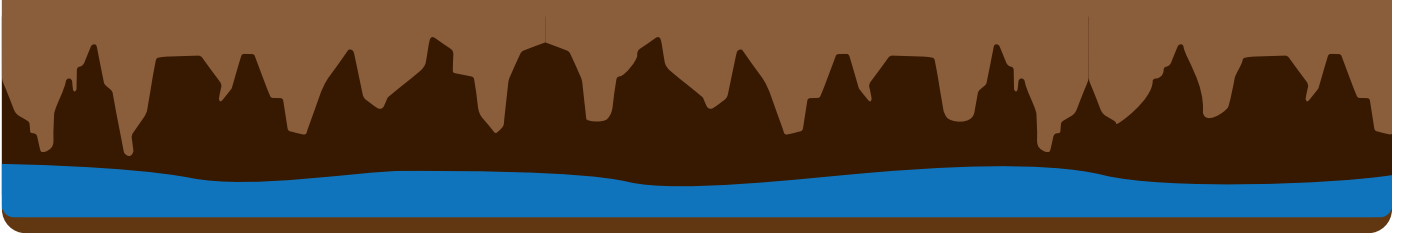

Flint Hills

Kansas is home to the famous Flint Hills. They are the last area of untouched tallgrass prairie in North America and considered one of the world's most endangered ecosystems. The Flint Hills start near the Kansas-Nebraska border and stretch 200 miles through eastern Kansas to the south into Oklahoma. The hills are made of flint and limestone which make the land difficult to plow, so the area has historically been used for ranching.

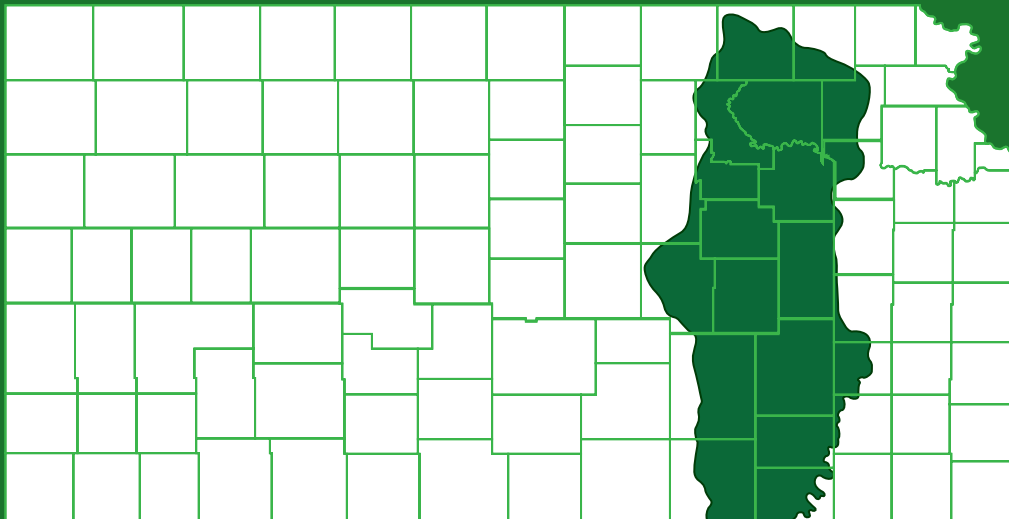

KANSAS COUNTIES

Kansas has 105 counties. Some counties were created before Kansas was even a state! Counties provide many important resources like local law enforcement, county courts, administrative services, local roads and parks. Each county serves as the local government for

the people living within the county. All counties have a clerk, treasurer, sheriff, attorney, register of deeds and, at least, three county commissioners. County Commissions are the governing body and make laws for the county.



ACTIVITY

Kansas Road Trip

Kansas is a big and diverse state with a lot to see. How many places have you visited? You can find more by visiting www.travelks.com.

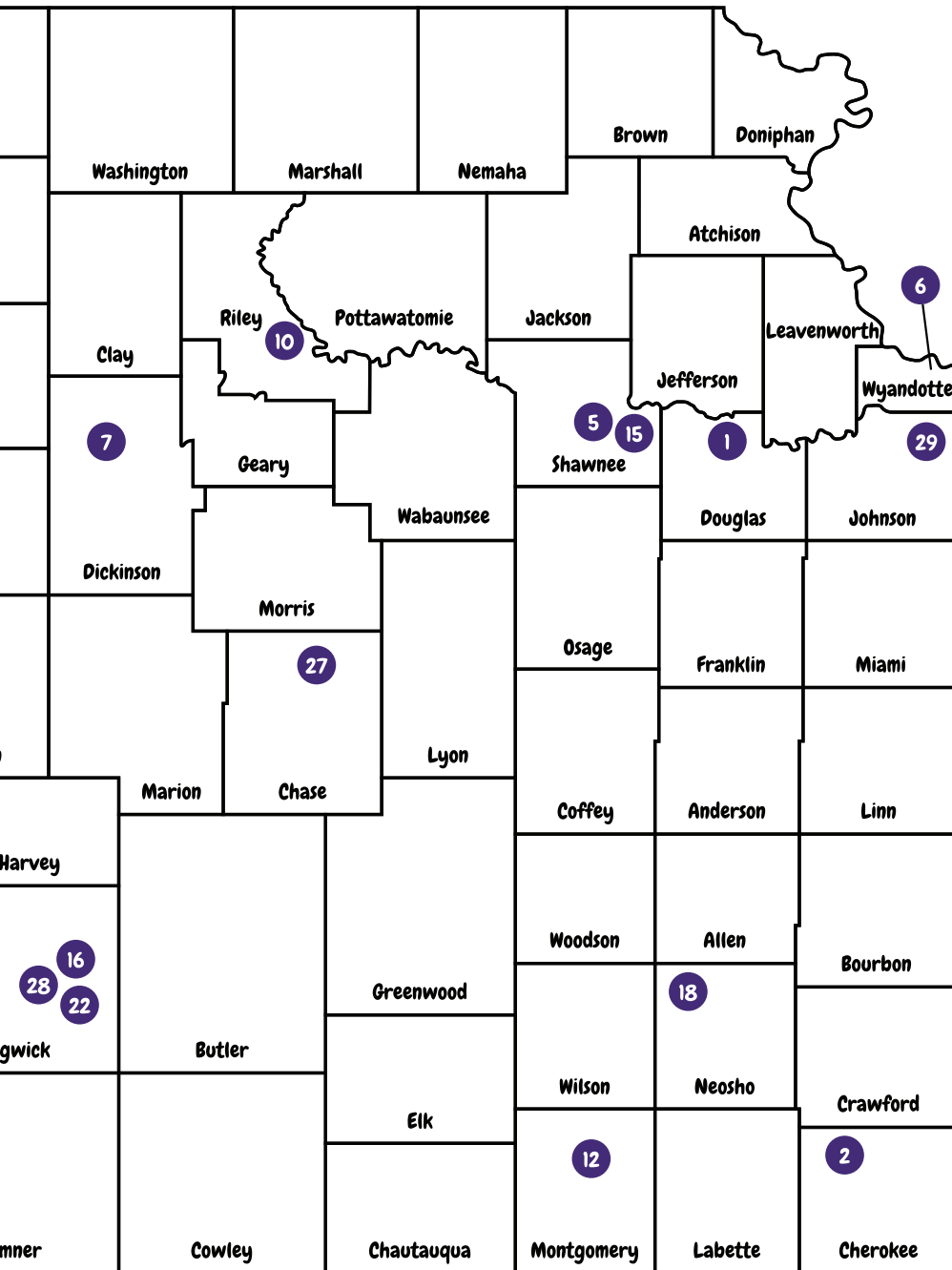

1. Booth Family Hall of Athletics (Lawrence)
2. Big Brutus (West Mineral)
3. Big Well (Greensburg)
4. Boot Hill Museum (Dodge City)
5. Brown v. Board of Education Site (Topeka)
6. Children's Mercy Park and Kansas Speedway (Kansas City)
7. Eisenhower Presidential Library & Museum (Abilene)
8. Fort Larned National Historic Site (Larned)
9. Prairie Museum of Art and History (Colby)
10. Flint Hills Discovery Center (Manhattan)
11. Cheyenne Bottoms Wildlife Area (Great Bend)
12. Kansas Celebrity Hall of Fame (Independence)
13. Kansas Cosmosphere (Hutchinson)
14. Syracuse Sand Dunes Park (Syracuse)
15. Kansas Statehouse (Topeka)
16. Keeper of the Plains (Wichita)
17. Arikaree Breaks (Cheyenne County)
18. Martin and Osa Johnson Safari Museum (Chanute)
19. Monument Rocks & Castle Rock (Gove County)
20. Mount Sunflower (Weskan)
21. Webster Reservoir, State Park & Wildlife Area (Stockton)
22. Old Cowtown Museum (Wichita)
23. Quivira National Wildlife Refuge (St. John)
24. Sandage Bison Range & Wildlife Area (Garden City)
25. Sternberg Museum of Natural History (Hays)
26. Strataca - Kansas Underground Salt Museum (Hutchinson)
27. Tallgrass Prairie National Preserve (Chase County)
28. Tanganyika Wildlife Park (Goddard)
29. Wonderscope Children's Museum (Shawnee)
30. World's Largest Ball of Twine (Cawker City)

KANSAS COMMERCE & INDUSTRY

Kansas has a diverse economy and is home to several large companies like Sprint, Garmin, Cobalt Boats, Cessna and more! The two largest industries in Kansas are aviation and agriculture, but we have many others like energy, animal health and advanced manufacturing. Since Kansas is located in the middle of the U.S. we are a perfect spot for manufacturing because items can be easily transported to major shipping ports near the Gulf of Mexico, Atlantic Ocean and Pacific Ocean for distribution around the world.

Aviation is very important to the Kansas economy. Some of the aviation industry's first pioneers, like Clyde Cessna and Walter Beech, made Kansas their home. Over 100 years later, Kansas remains a leader in aviation manufacturing. More than half of the world's aircraft is produced in Kansas which means the next time you fly on an airplane it probably has a part on it that was made in Kansas! There are a lot of aviation and aerospace companies in Kansas. Wichita is nicknamed the "Air Capital of the World" because companies like Bombardier Learjet, Cessna, Hawker Beechcraft, Airbus and Spirit AeroSystems are all located there.

Agriculture has played an important role in the economy of Kansas for a long time! Nearly 50 MILLION acres of land are used for livestock and farming in the state. Kansas is number one in wheat production. We grow nearly 15 percent of the wheat produced in the United States. Kansas is also in the top three of beef producers. Other leading agriculture products from Kansas are corn, soybeans, sugar beets, oats, sheep and hogs.

Biosciences, a combination of agriculture, medicine and science, play a big role in the Kansas economy. Industries like animal and pet nutrition, pharmaceuticals and human health are rapidly growing. The Kansas City Animal Health Corridor has over 300 companies who specialize in animal health, diagnostics and pet food.

Kansas also has many natural resources that help support our economy. If you've spent any time outside, you know Kansas can be windy and sunny! We are in the "wind corridor" and ranked second in wind potential. Many companies have come to Kansas to use our wind and sun to create new sources of energy.



ACTIVITY

Connect the dots to draw objects that are important parts of Kansas industry.

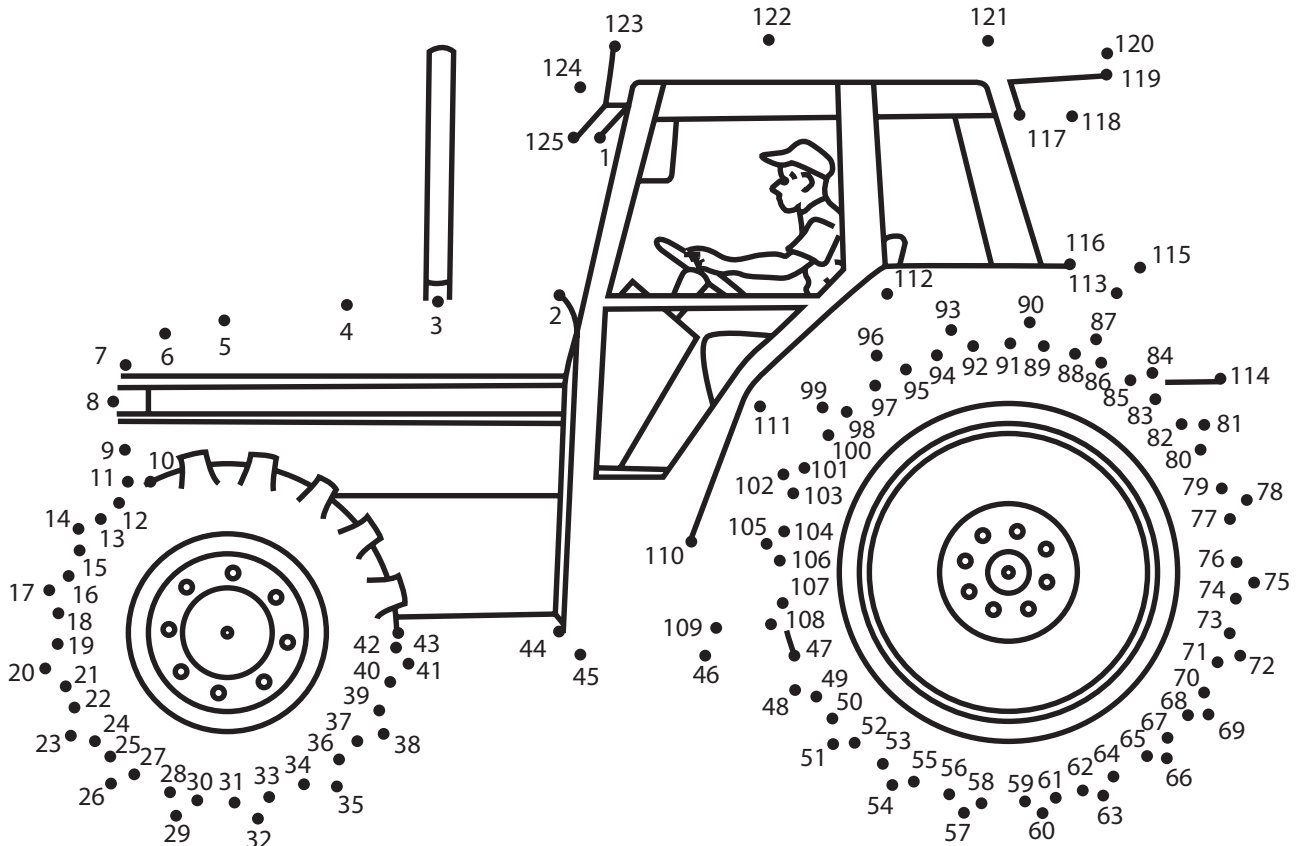
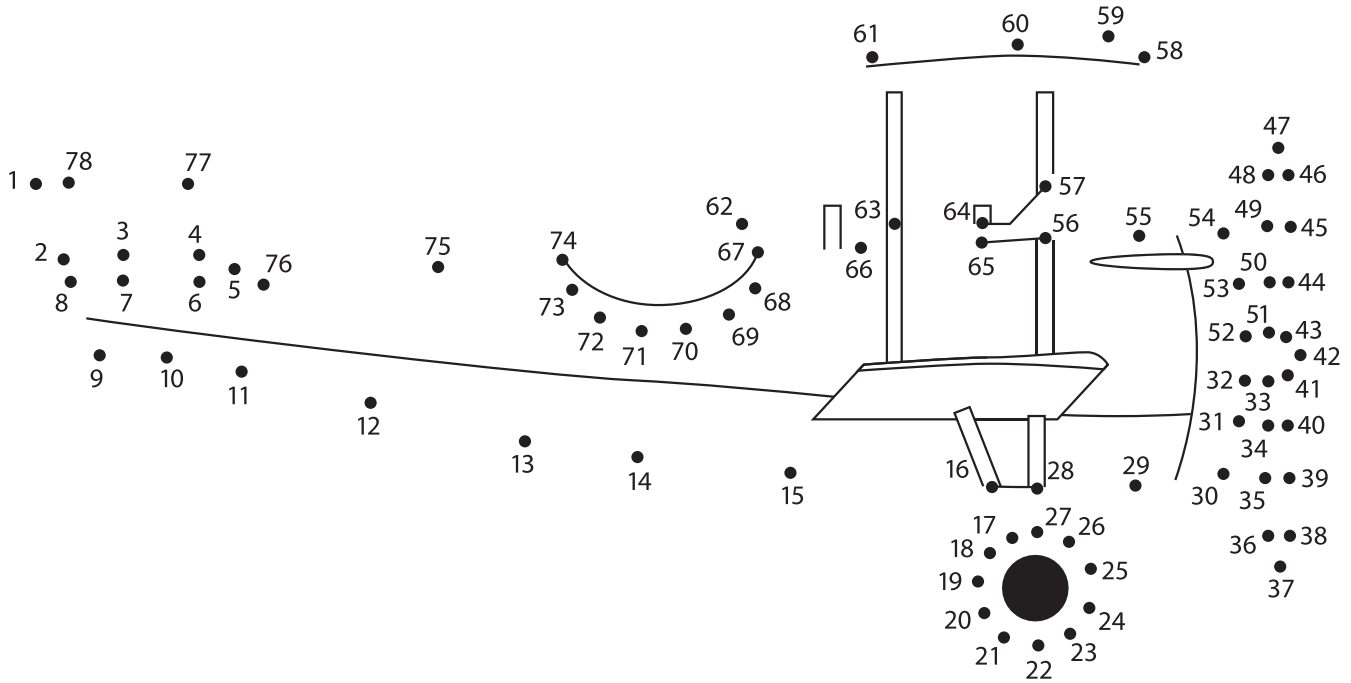

FAMOUS KANSANS

Kansas has a wide variety of famous residents and listed below are just a few.



Historical Figures

John Brown
George Armstrong Custer
Buffalo Bill Cody
Wyatt Earp

Wild Bill Hickock
Bat Masterson
Carrie Nation
Satanta



Athletes & Coaches

Clint Bowyer
Jordy Nelson
Adolph Rupp
Barry Sanders

Dean Smith
Bill Snyder
Tom Watson
Gary Woodland



Politicians & Government Officials

Nancy Landon Kassebaum
Bob Dole
Robert Gates
Georgia Neese Clark Gray

Cyrus Holliday
Alfred Landon
Richard B. Myers
Arlen Specter



Artists, Writers & Poets

Gwendolyn Brooks
John Steuart Curry
Aaron Douglas
Langston Hughes

Elizabeth Layton
Bill Martin, Jr.
Gordon Parks
Charles Sheldon



Pioneers, Inventors & Business Leaders

Walter & Olive Ann Beech
Clyde Cessna
Walter Chrysler
William Coffin Coleman

Edward Dwight, Jr.
Amelia Earhart
William Hodkinson
Harry Ford Sinclair



Movies, Television & Music

Kirstie Alley
Melissa Etheridge
Nicole Galyon
Don Johnson

Jennifer Knapp
Jim Lehrer
Jeff Probst
Paul Rudd

ACTIVITY

Can you match the description to the famous Kansan? Draw a line from each box to the name of the person you think it matches with.

This colorful figure was a soldier, buffalo hunter and showman. After the Civil War he settled near Fort Hays where he earned his famous nickname as a contract buffalo hunter for the Army and Kansas Pacific Railroad.

Charles Curtis

Kansas

From Wichita, she is considered one of the greatest female basketball players of all time. She set the record for most career points in the women's Division I basketball history – 3,649 points – while playing at KU.

She was the first woman elected to political office in the United States in 1887. She was nominated as a joke but was successful in being elected mayor of Argonia, Kansas.

Hattie McDaniel

Buffalo Bill Cody

This newspaper editor, politician and author wrote for the Kansas City Star and purchased the Emporia Gazette in 1896. Known for his blistering editorials, he won a Pulitzer Prize in 1923 for his editorial writing.

He represented Kansas in the U.S. House of Representatives and U.S. Senate before becoming vice president under President Herbert Hoover. He is the first Native American descendant to serve as vice president.

Martina McBride

Eric Stonestreet

Born in Wichita, she was a professional singer-songwriter, radio performer and actress who was the first African American woman to sing on the radio and the first African American to win an Academy Award for her role in *Gone with the Wind*.

He is the first and only Kansan to be elected as president. Serving as the 34th president of the United States, he previously was a five-star general in the U.S. Army and served as supreme commander of the Allied Forces in Europe during World War II.

James Naismith

William Allen White

This funny Kansan has appeared on *Modern Family*, *CSI: Crime Scene Investigation*, *Dharma & Greg* and *Malcolm in the Middle*. You can also find him routinely cheering on the Kansas State University Wildcats!

This Kansan established a famous candy company from his kitchen in 1924. Today, his company is the nation's leading manufacturer of boxed chocolates and the third largest American chocolate manufacturer.

Susanna M. Salter

Lynette Woodard

She is a famous country music singer who has recorded 17 albums. Born in Sharon, Kansas, she has been named country music female vocalist of the year six times and has been nominated for a Grammy Award 14 times.

This person came to Kansas in 1898 to work as a chaplain, physical education instructor at the University of Kansas and later became KU's first basketball coach. The basketball court in Allen Fieldhouse is named in his honor.

Dwight D. Eisenhower

Russell Stover

This rock band became popular in the 1970s and 1980s. Founded in Kansas, this band is named after our state. Two of their most popular songs are "Carry on Wayward Son" and "Dust in the Wind."

KANSAS FUN FACTS

Did you know?

Denver, Colorado was named after Kansas Territorial Governor James W. Denver.



The state flower, the sunflower, has between 1,000 and 2,000 individual flowers joined at the base. The large, yellow petals are individual flowers that do not develop into seeds.



It would take one train stretching from western Kansas to the Atlantic Ocean to carry all the wheat grown in Kansas each year.



Annually, Kansas produces enough wheat to bake 36 billion loaves of bread. This is enough to feed everyone in the world for two weeks.



The GM Automobile Plant in Kansas City, Kansas is the most productive assembly plant in North America.



Kansas makes more airplanes than any other place on earth. Over 250,000 aircraft have been made in Kansas since 1919.



Kansas is in the top 10 in the United States for producing beef, sunflowers, flour, hay, corn and soybeans.



The National Climate Data Center named Dodge City, Kansas the windiest city in the United States.

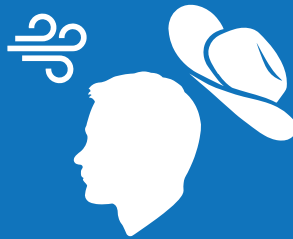

Kansas averages 300 sunny days a year.



Helium was first discovered near Dexter, Kansas in 1903.



There are three astronauts from Kansas - Joe Engle, Ron Evans and Steve Hawley. Evans even went to the moon.



Do you like pizza? The Pizza Hut restaurant franchise was started in Wichita, Kansas in 1958.



ACTIVITY

Can you find the words associated with Kansas? The words can go up, down, diagonal and backwards.

W	I	L	D	C	A	T	S	T	H	G	H	B	S	J	F
N	I	L	N	H	I	D	U	X	C	Y	U	Q	H	N	C
Z	S	H	A	O	O	G	V	X	L	A	G	T	O	P	A
S	U	P	U	B	P	R	K	J	T	H	O	R	C	F	T
N	D	L	A	W	I	A	C	C	D	P	T	C	K	I	T
F	B	H	L	F	K	L	H	M	O	A	O	Y	E	X	L
E	C	C	J	E	W	I	E	X	D	F	N	Y	R	R	E
I	O	U	P	W	S	L	D	N	G	Q	N	G	S	N	F
B	N	O	M	O	F	F	I	V	E	K	E	W	G	C	S
U	T	S	N	R	T	C	H	G	C	A	J	J	I	O	R
H	U	Q	I	Y	T	A	G	T	I	G	E	R	S	N	M
J	A	Y	H	A	W	K	S	B	T	O	E	G	W	K	D
W	T	X	K	S	C	H	S	K	Y	M	S	Z	A	A	S
P	K	A	H	R	L	X	E	Z	T	R	L	N	F	T	S
R	E	Z	A	T	O	M	F	A	B	W	E	J	E	L	F
A	V	Z	Y	R	K	T	W	B	T	C	R	N	M	A	A
I	B	O	S	H	D	C	J	U	O	C	R	C	A	Q	R
R	A	Z	I	B	I	B	B	L	D	O	M	J	O	K	M
I	R	X	N	A	A	W	I	C	H	I	T	A	J	R	F
E	F	P	G	O	R	I	L	L	A	S	A	O	A	I	N

ABILENE
ATCHISON
CATTLE
CORN
DODGECITY

FARM
GORILLAS
HAYS
HORNETS
HUGOTON

ICHABODS
JAYHAWKS
PRAIRIE
SHOCKERS
TIGERS

TOPEKA
WHEAT
WICHITA
WILDCATS
WIND



Provided by
Kansas Secretary of State Scott Schawb
1st Floor, Memorial Hall
120 SW 10th Avenue
Topeka, KS 66612
785-296-4564
sos.ks.gov
[@KansasSOS](https://www.instagram.com/KansasSOS)